



# NEXO KNIGHTS



70325







1

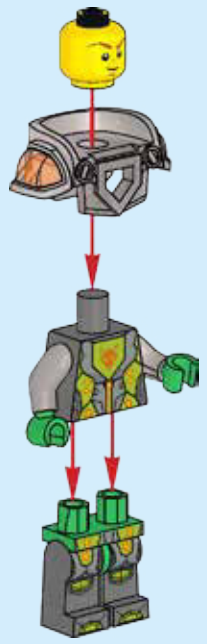

2

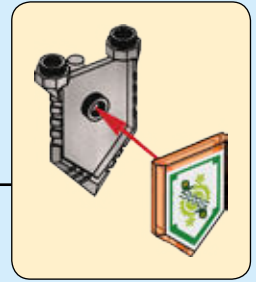
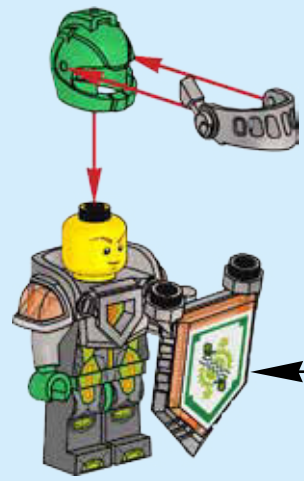

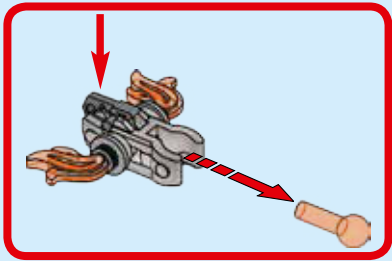
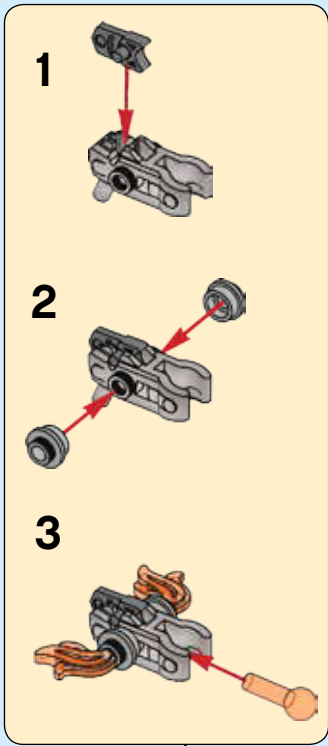

3

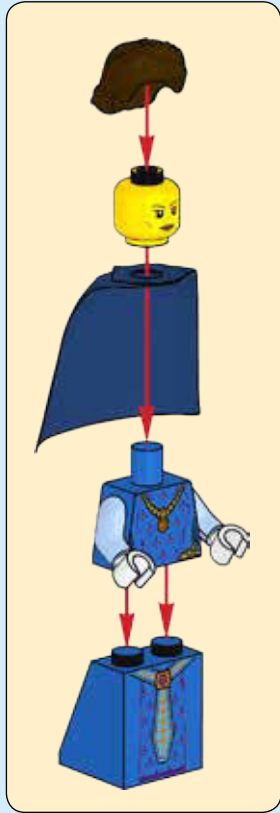

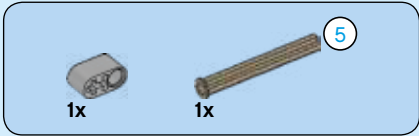

1

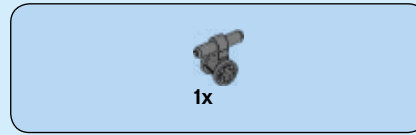
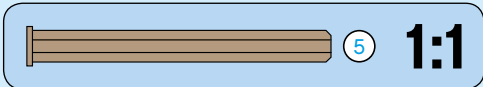
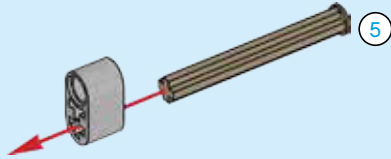

2

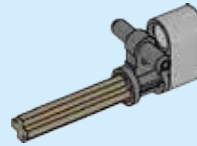



3x

# 3

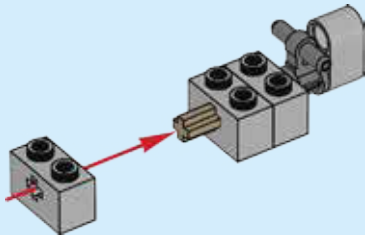

1x



1x



1x

# 4

1

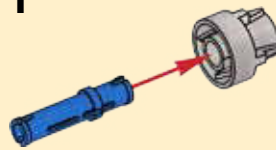

2

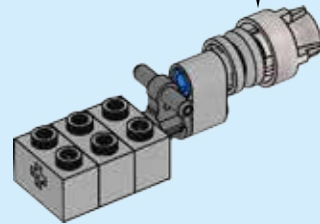
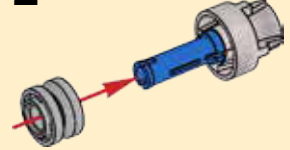

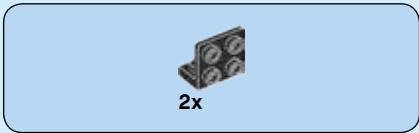

5

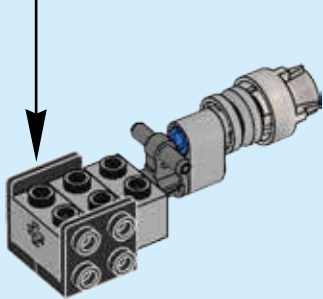
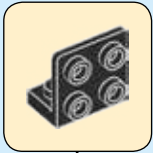

6

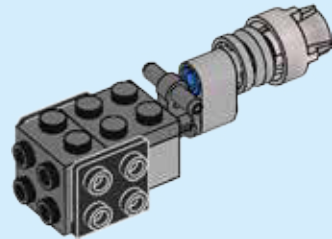



2x

7

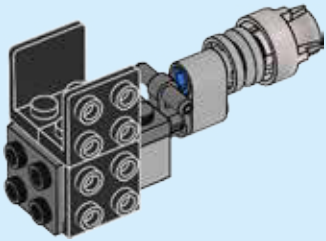

2x

8

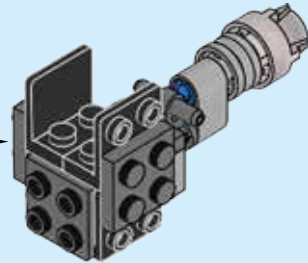
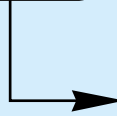
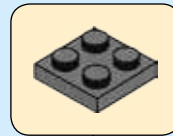





2x

# 9

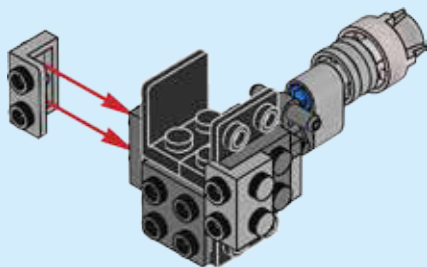

2x

# 10

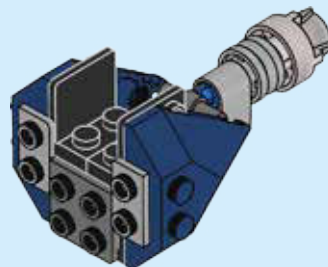



2x



1x

# 11

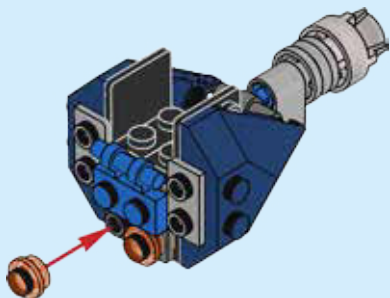

2x

# 12

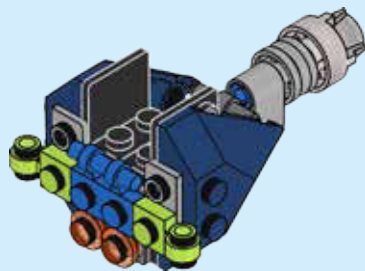



2x



2x

# 13

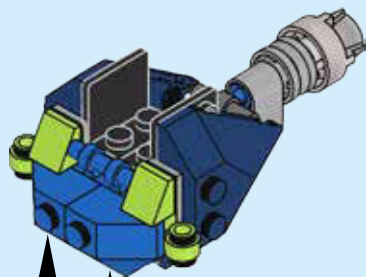

2x

# 14

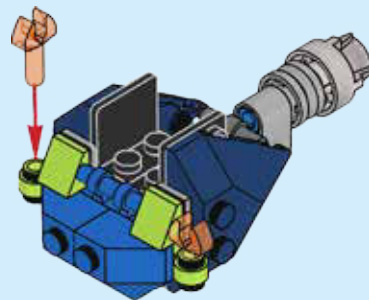



# 15

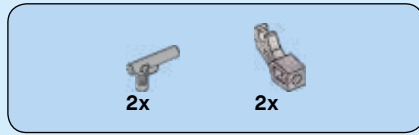
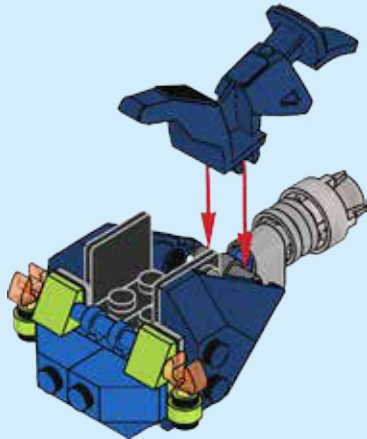

# 16

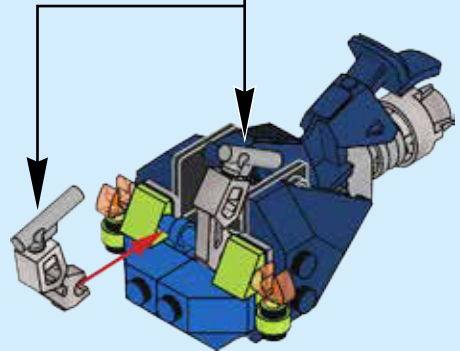
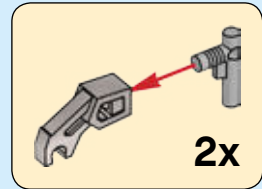

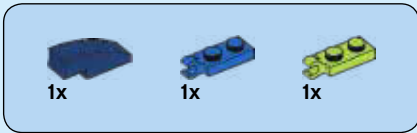

# 17

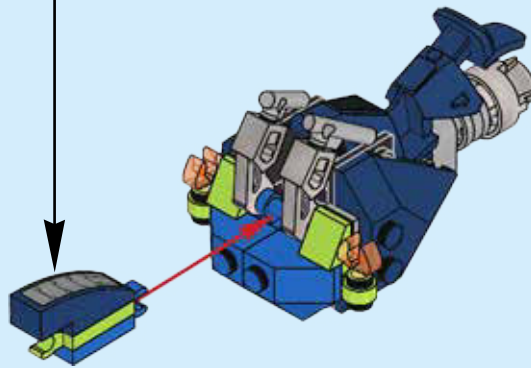
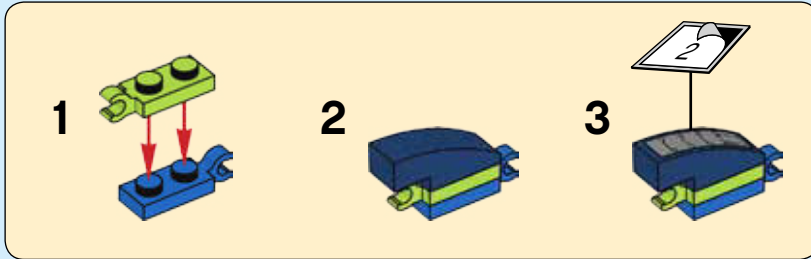

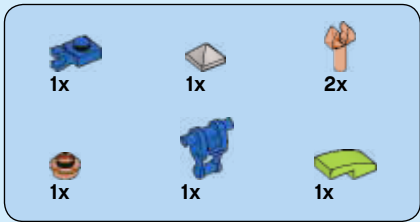

# 18

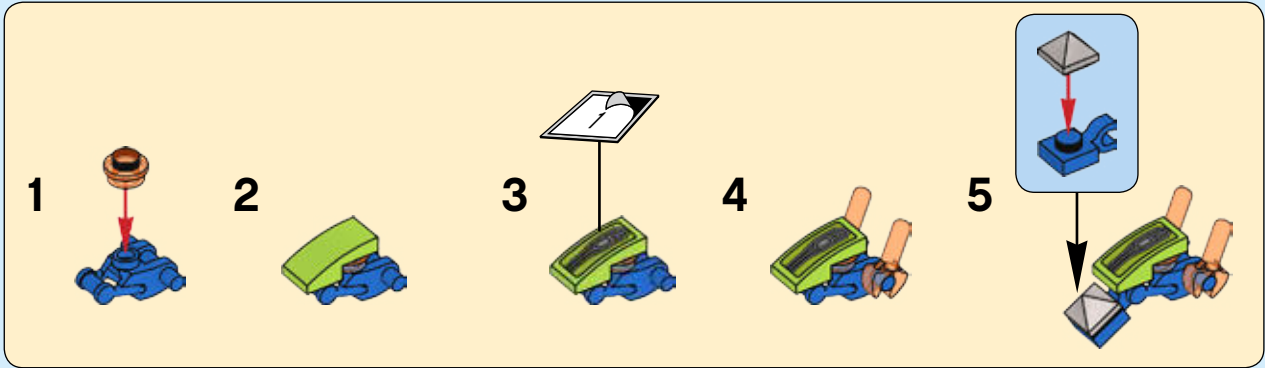

19

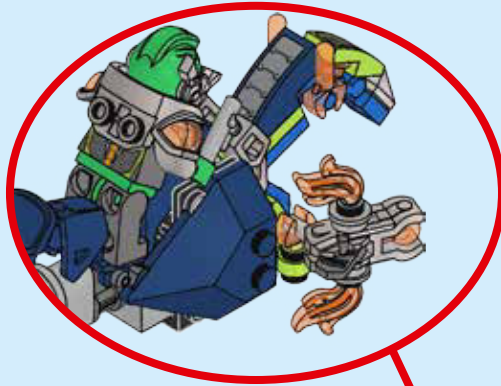

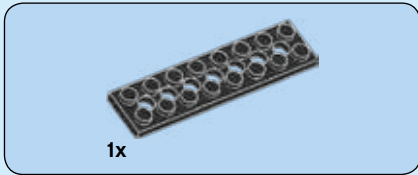

1

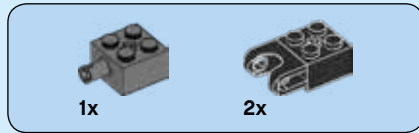
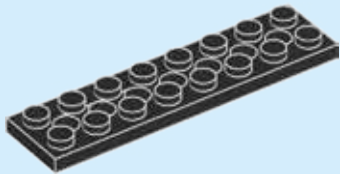

2

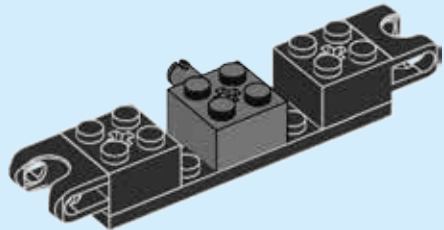



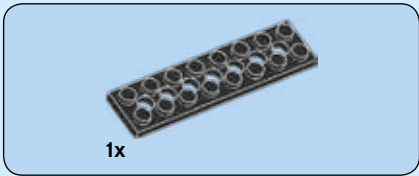

3

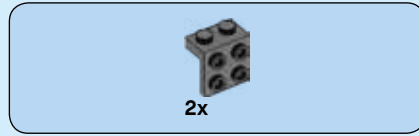
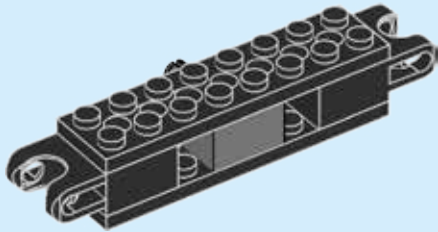

4

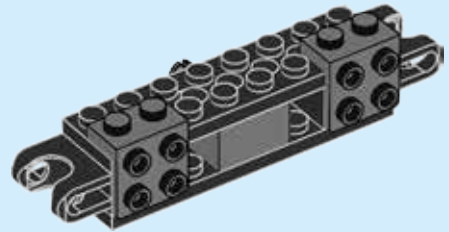



2x

5

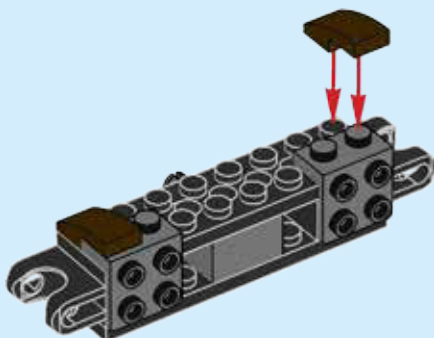

2x

6

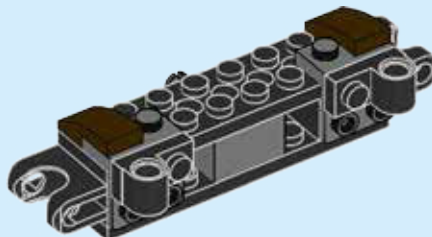



7

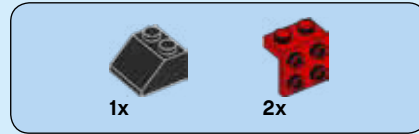
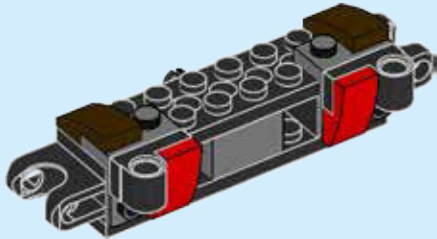

8

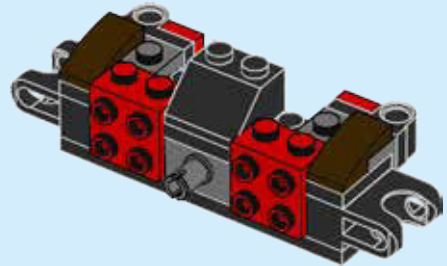
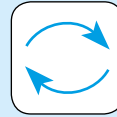



2x



2x

# 9

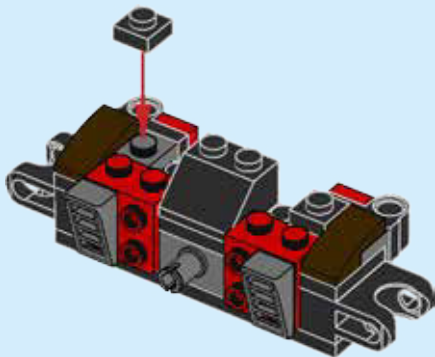

2x

# 10

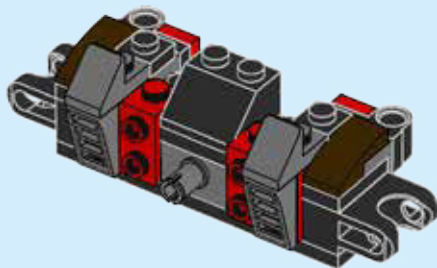

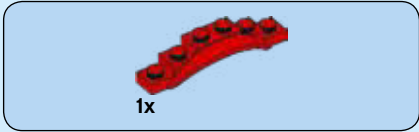

1x

# 11



2x

# 12

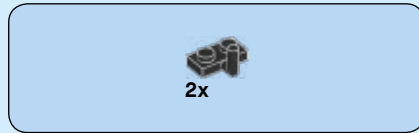
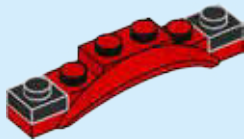

2x

# 13





# 14

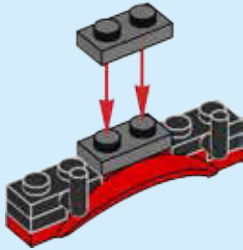

# 15

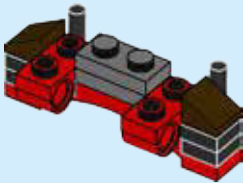
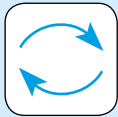

# 16

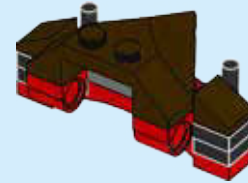

# 17

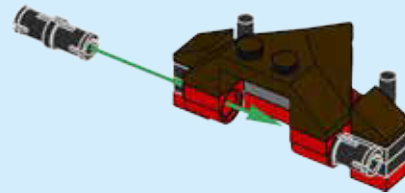



2x



2x

# 18

1



2



2x

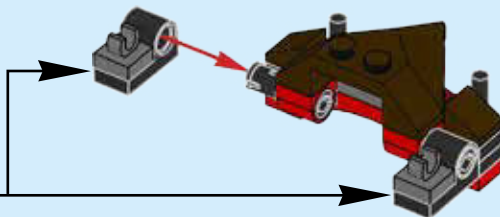

# 19

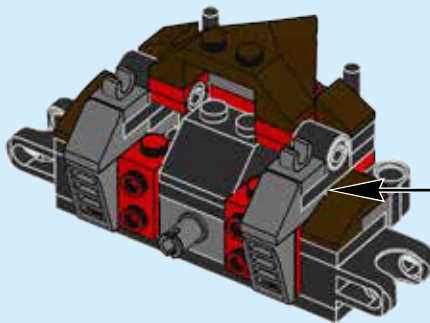

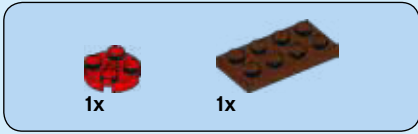

20

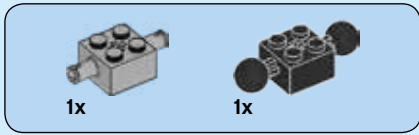

21

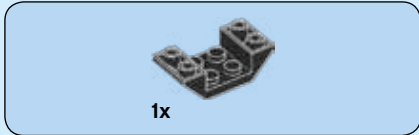
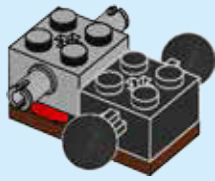

22

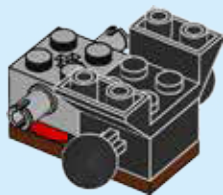



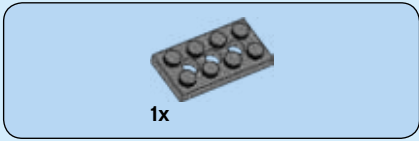

23

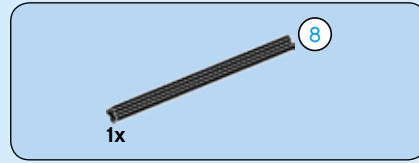

24

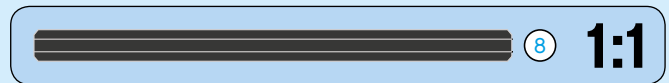
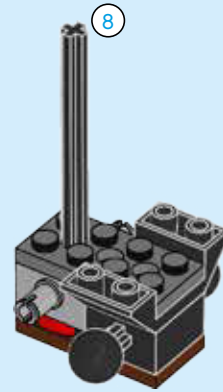



1x

# 25

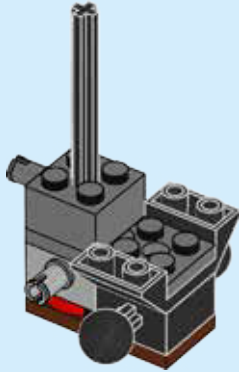

1x

# 26

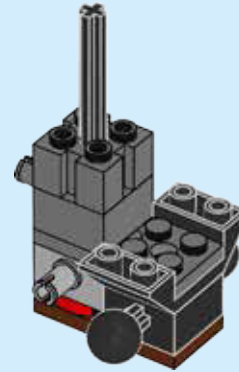



1x

# 27

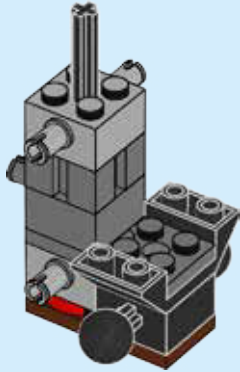

2x

# 28

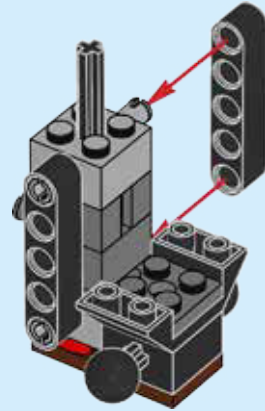



2x

# 29

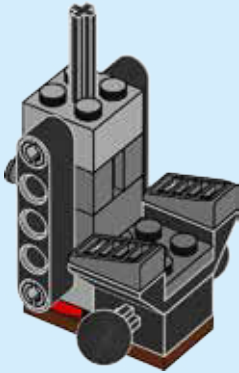

# 30

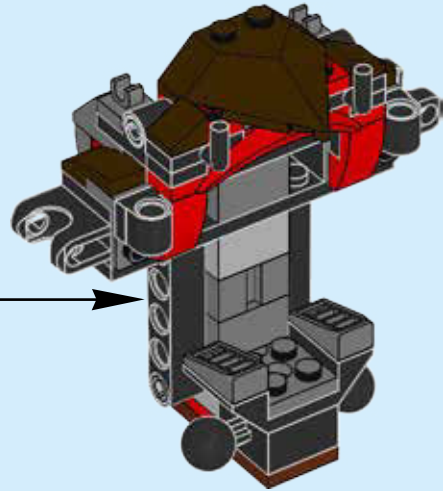
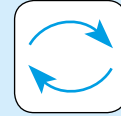

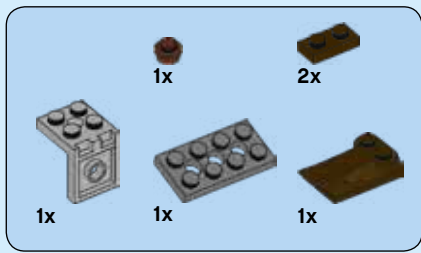

# 31

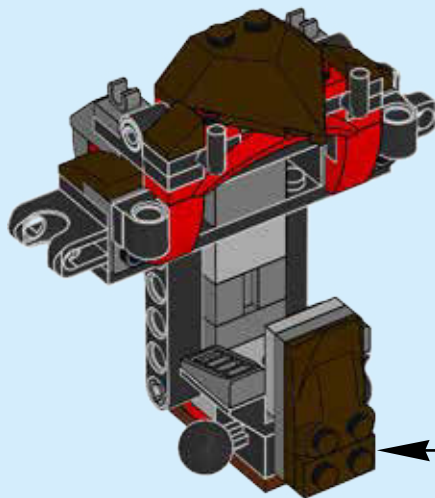
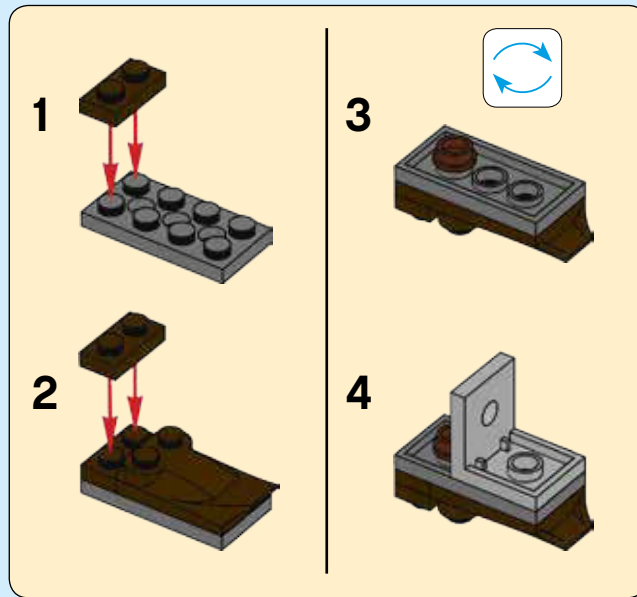



# 32

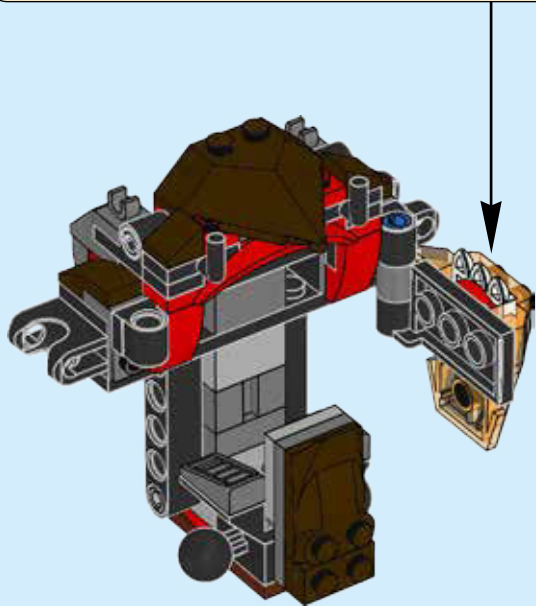
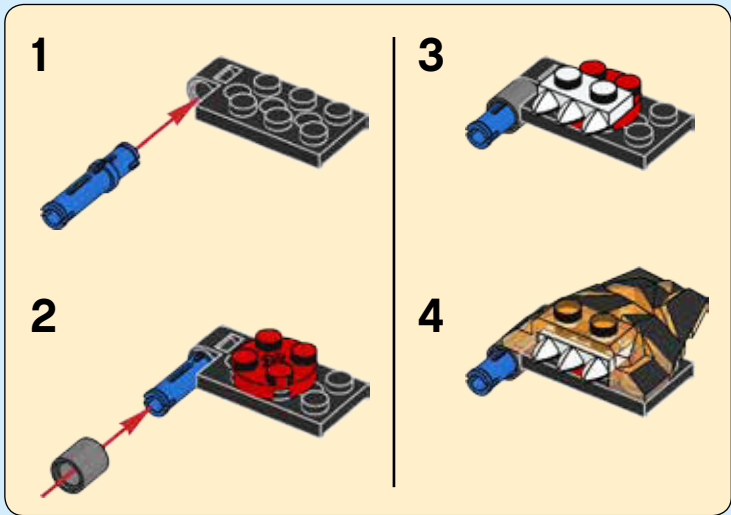

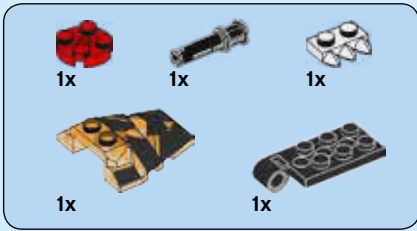

# 33

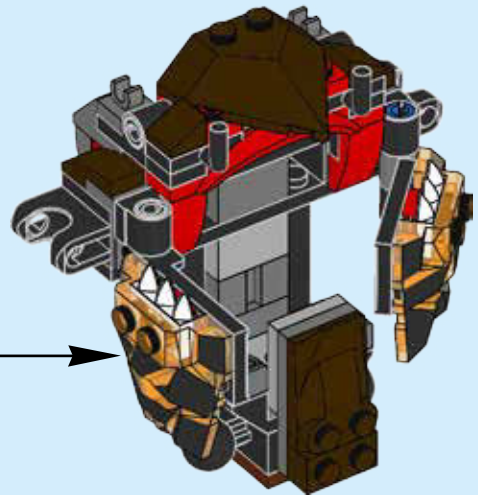
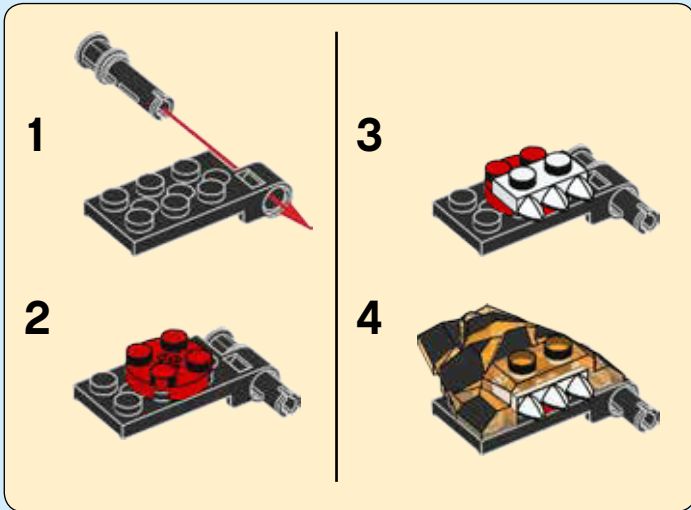

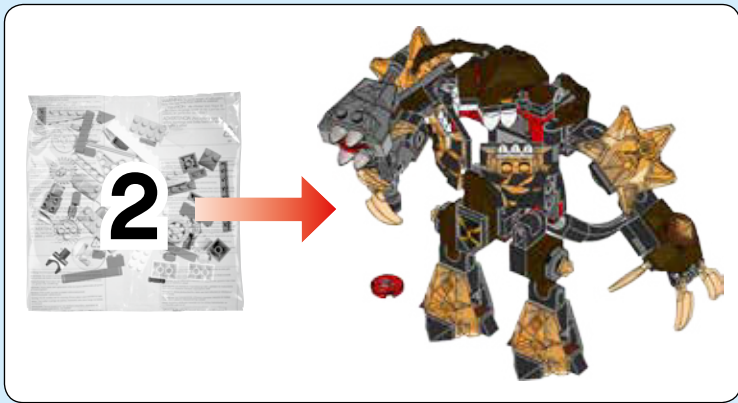

**34**

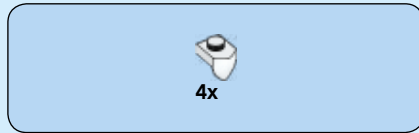

**35**

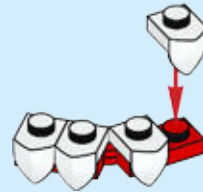

**36**

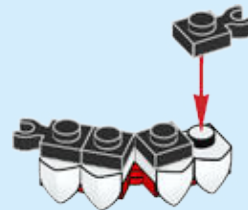





2x

37



2x

38



39





2x

40

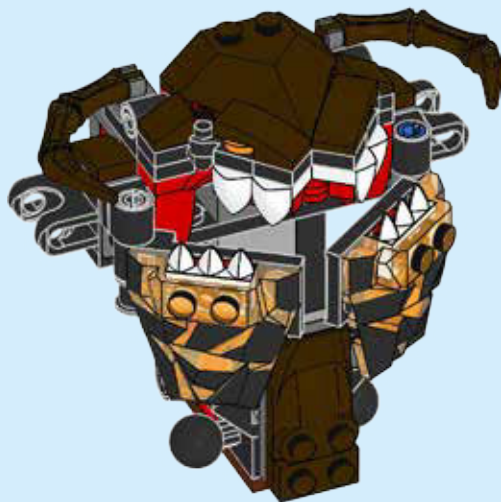



2x



1x

# 41

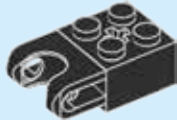

1x

# 42



1x

# 43

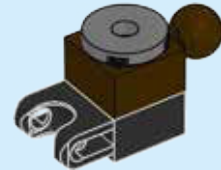

3

1x

# 44

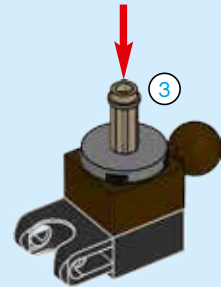

3

1:1



1x

# 45

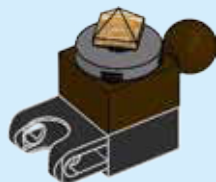

# 2x

# 46

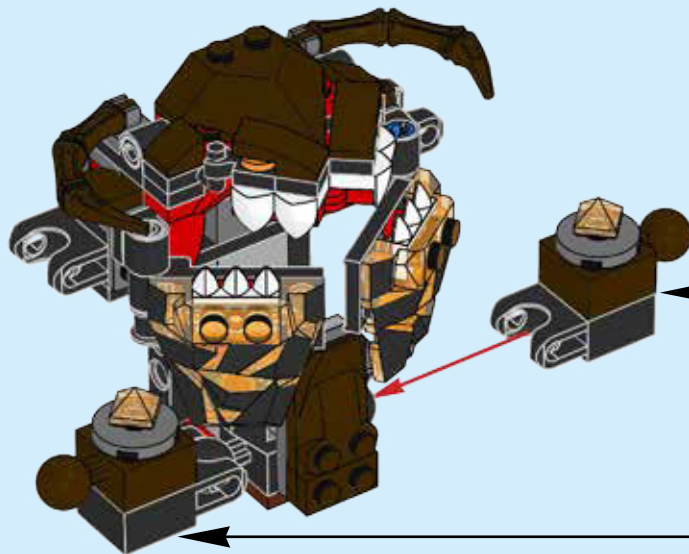



2x

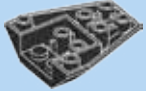

1x

47

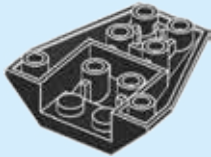

1x

48

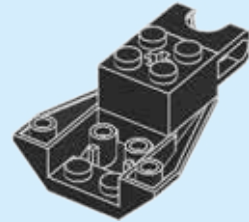

1x

49

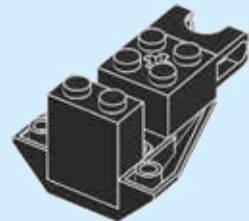



1x



2x

# 50

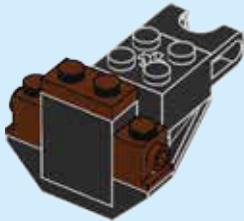

1x

# 51



1x



2x

# 52

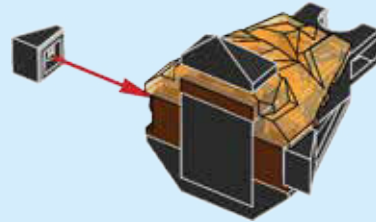

# 2x

53

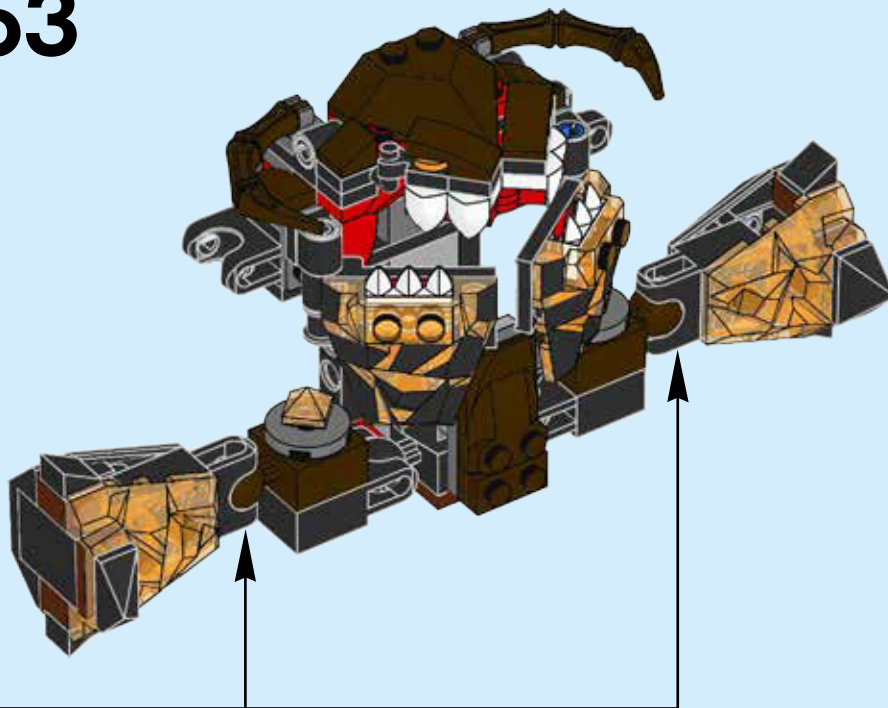



1x

# 54

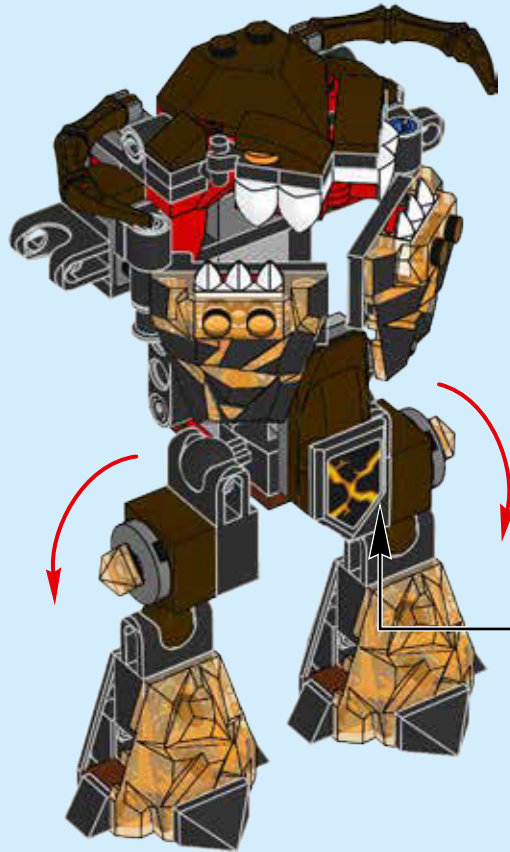

1



2





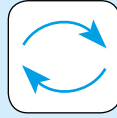
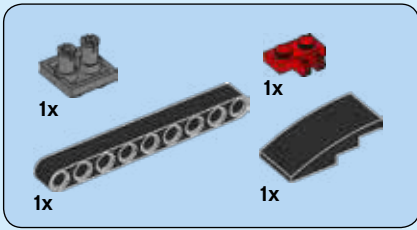

# 55

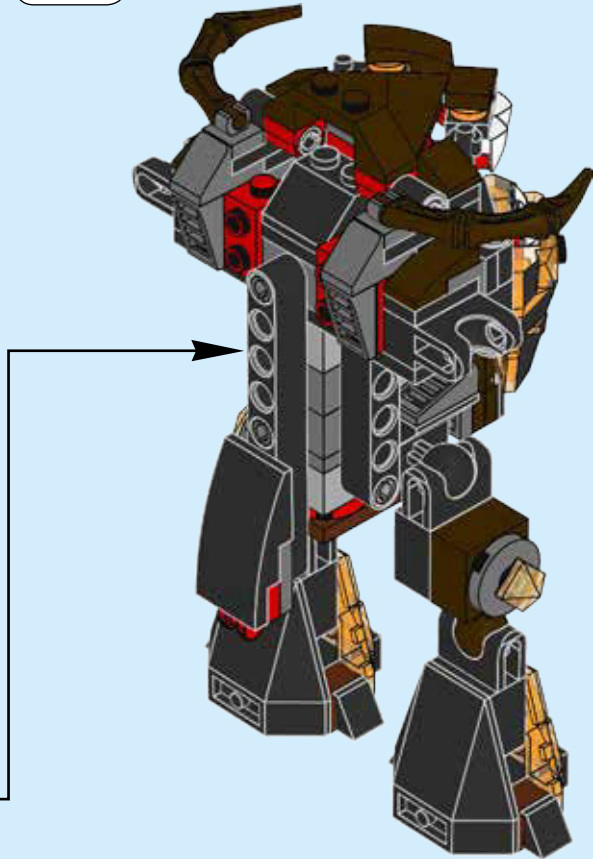
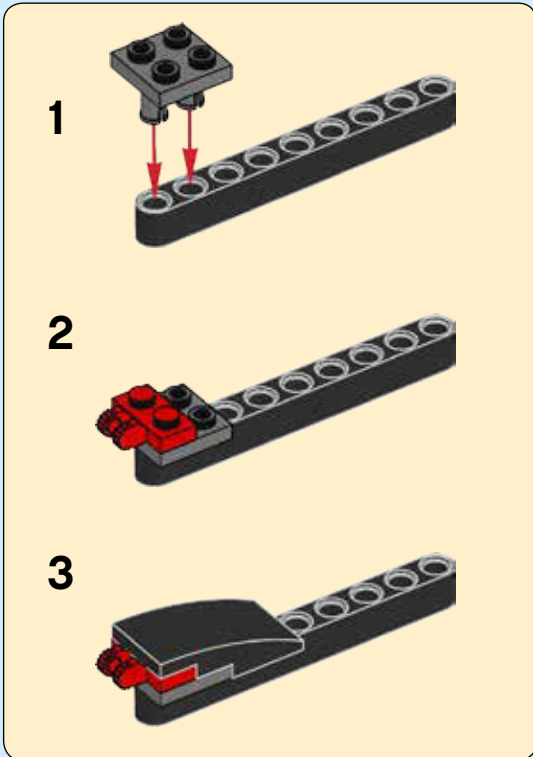

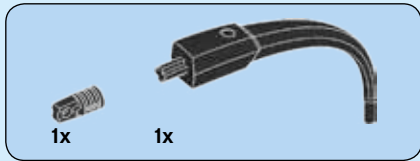

# 56

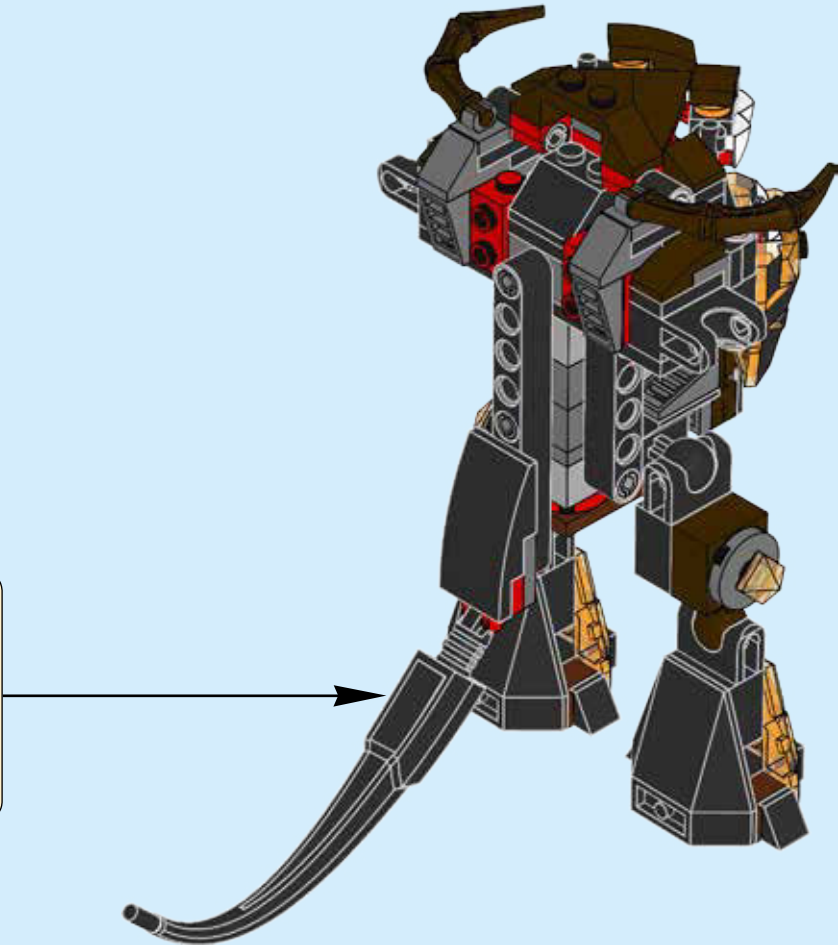
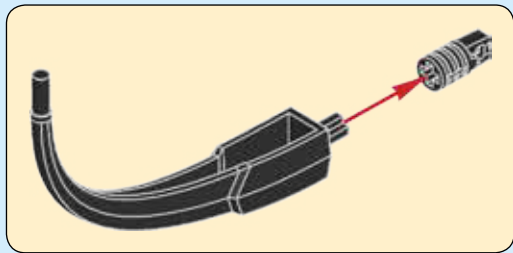

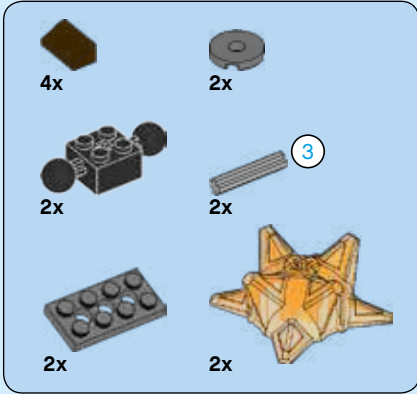
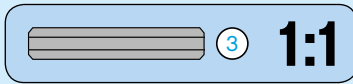

57

1

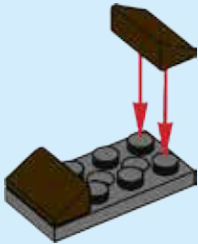

2

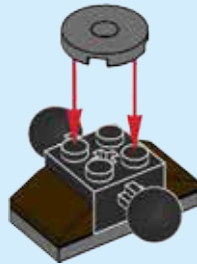

3

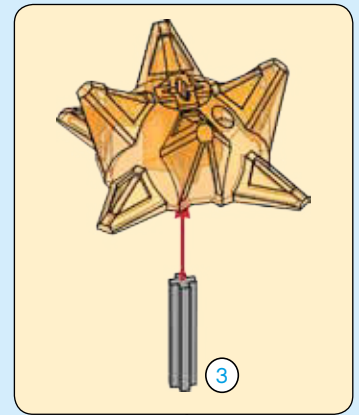
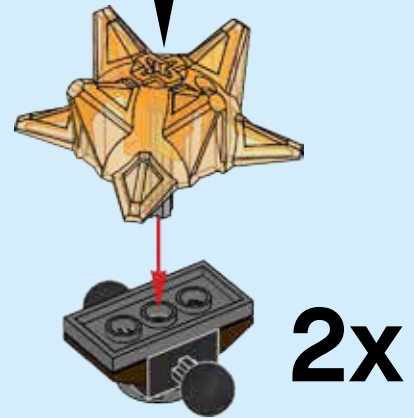

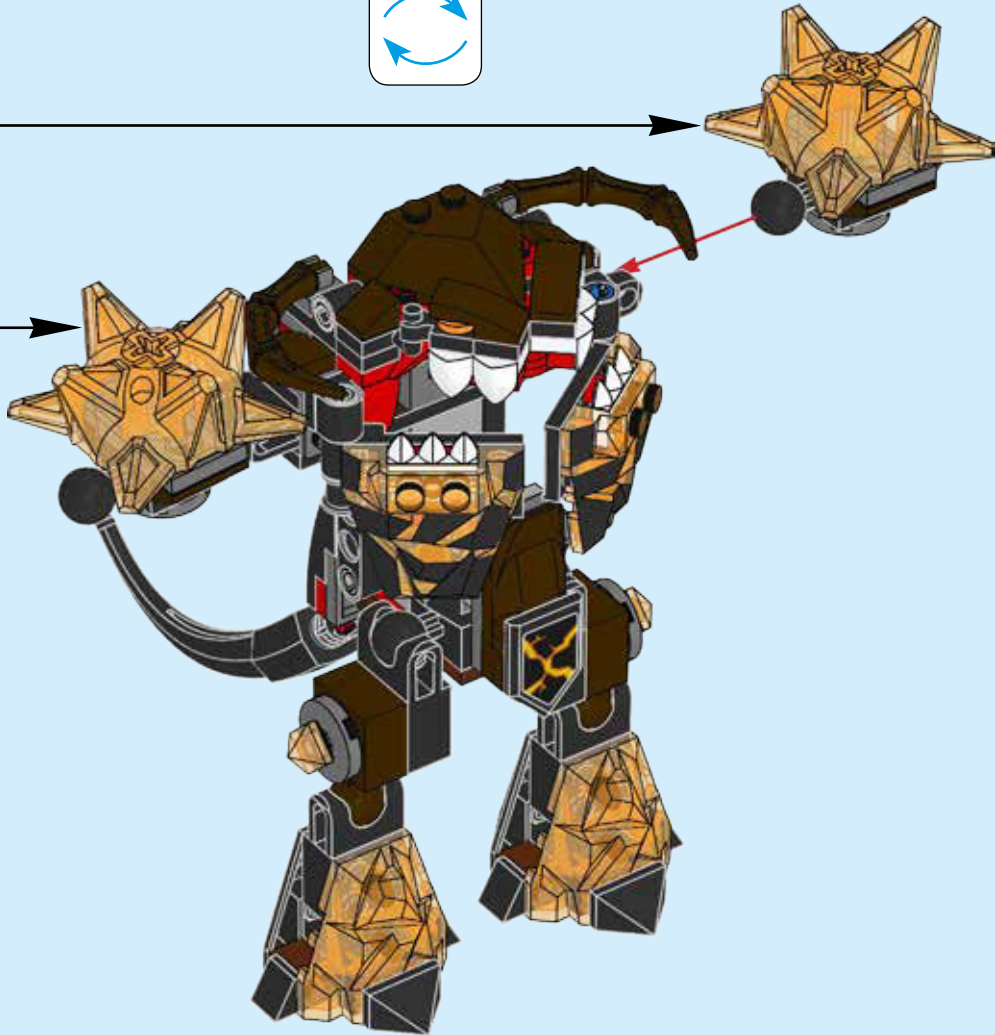
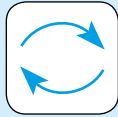



2x



1x

58

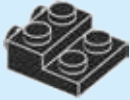

1x

59

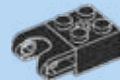
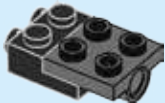

1x

60

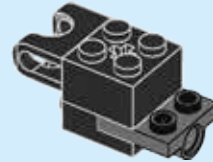

1x

61

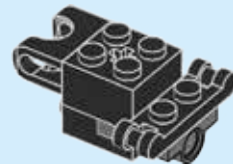



62



63



64

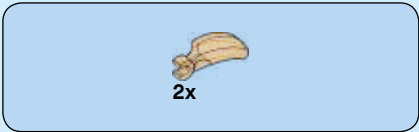

65

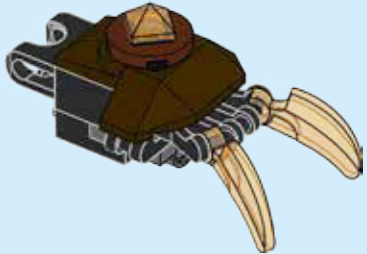

2x

66

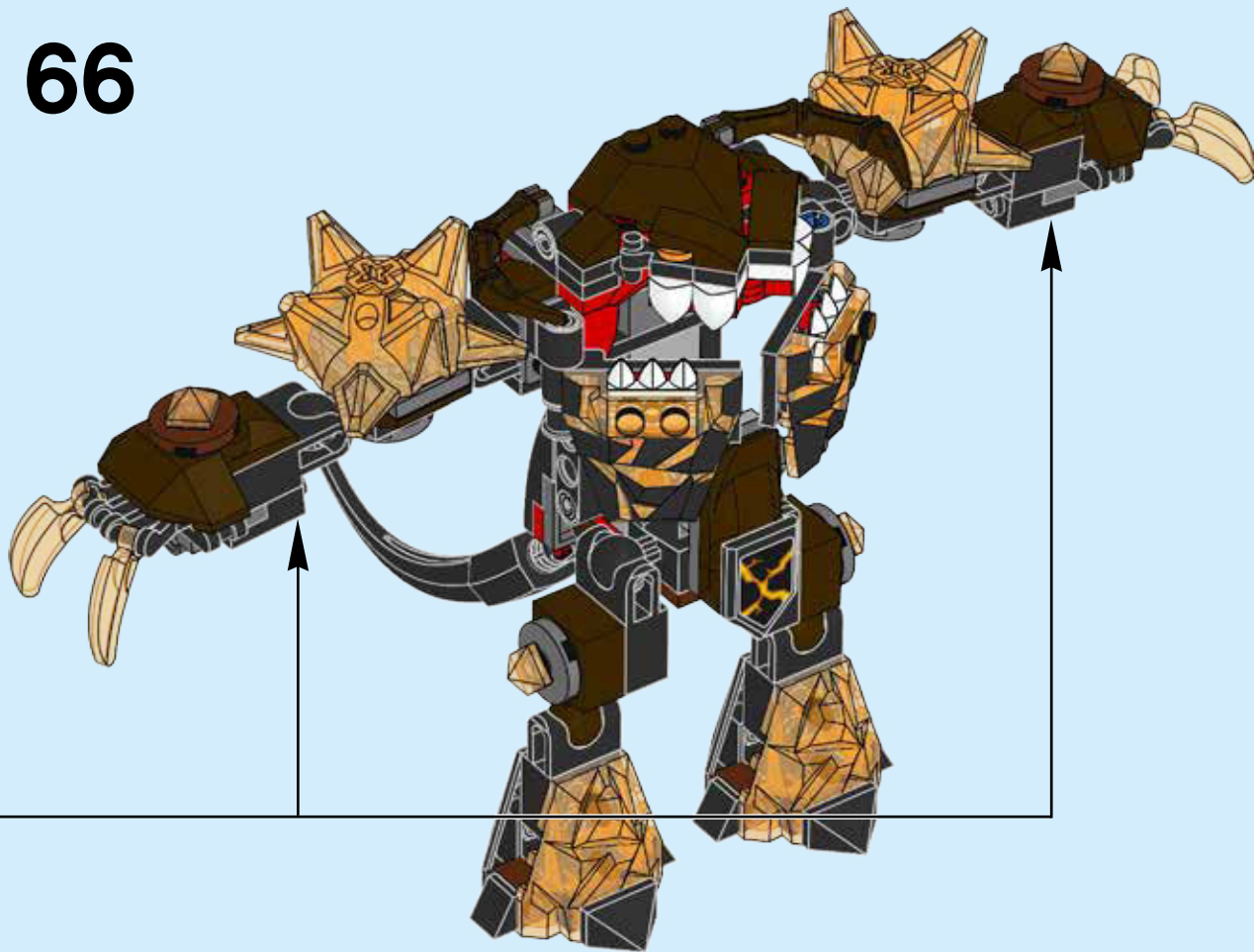



2x

# 67

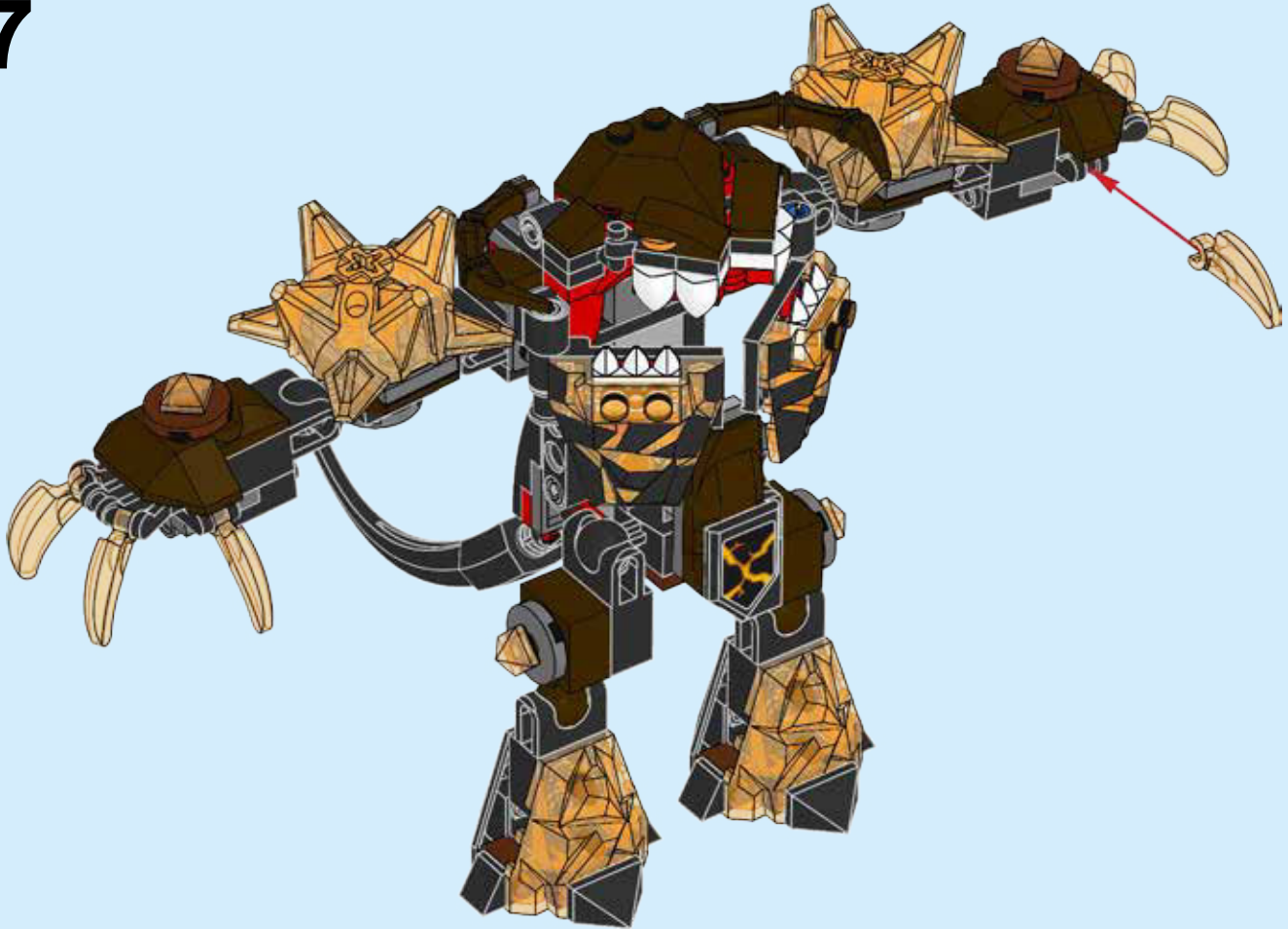



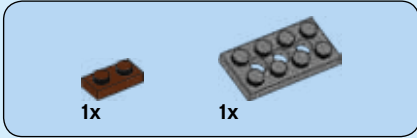
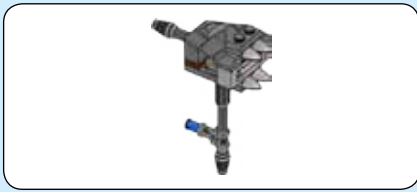

68

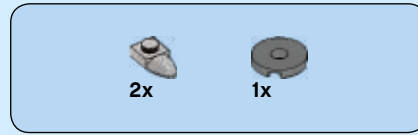
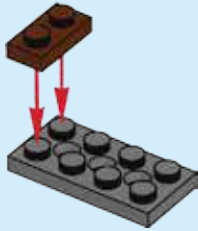

69

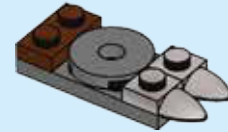

70

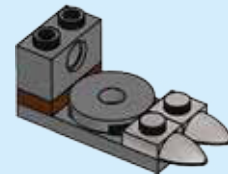

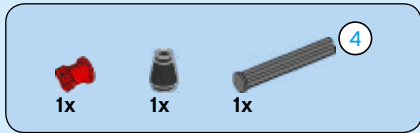

71

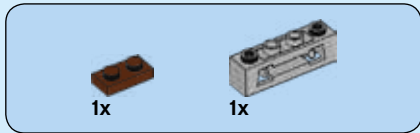
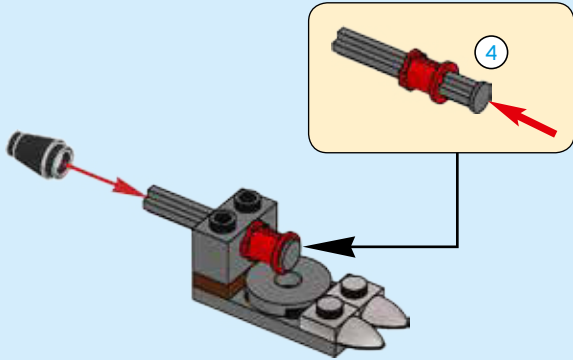

72

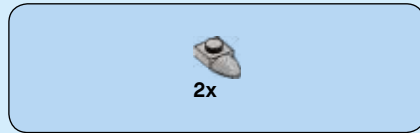
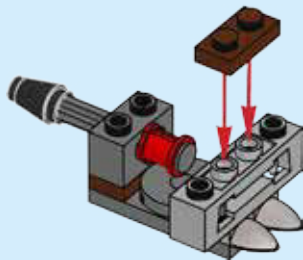

73

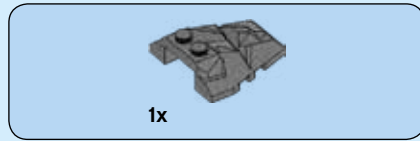
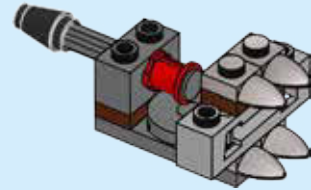

74

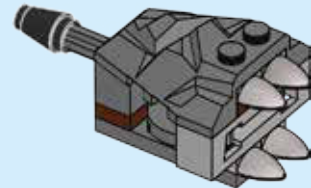

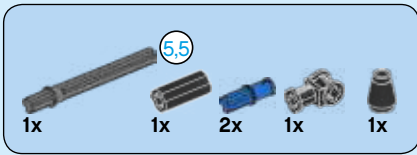

# 75

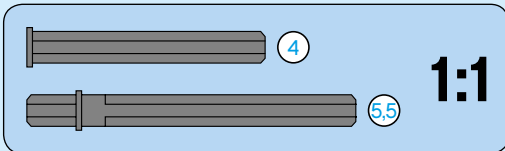
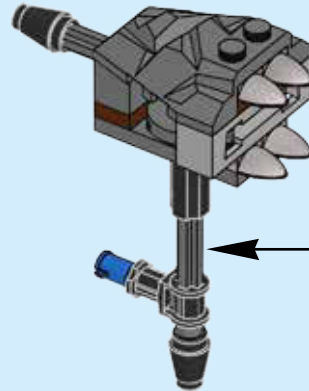
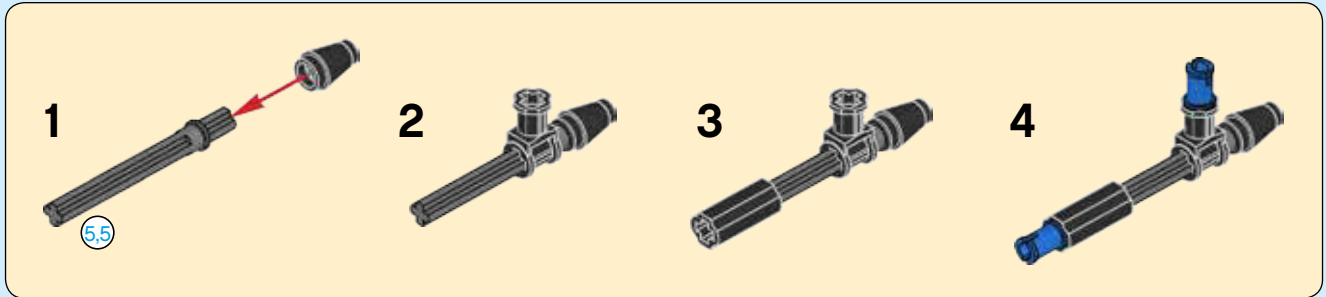

76

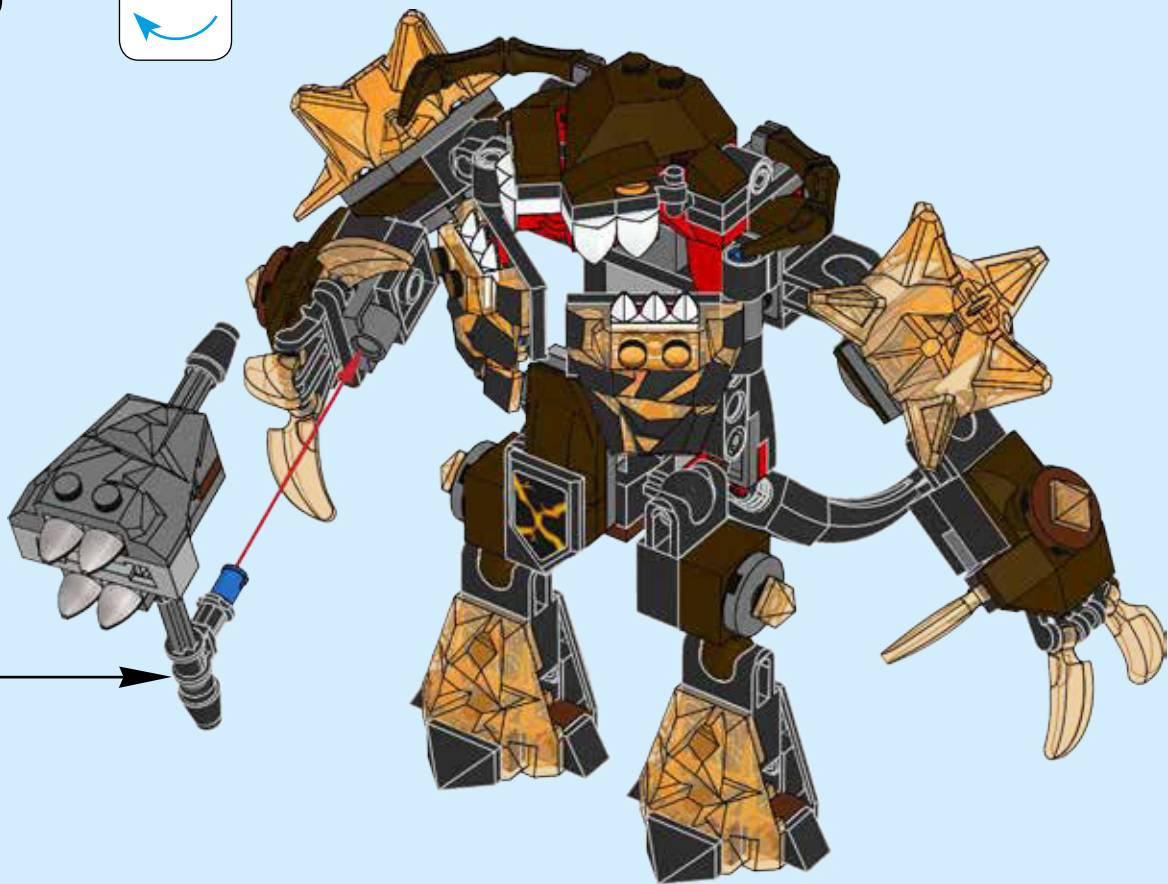
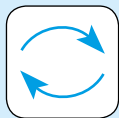



2x



77

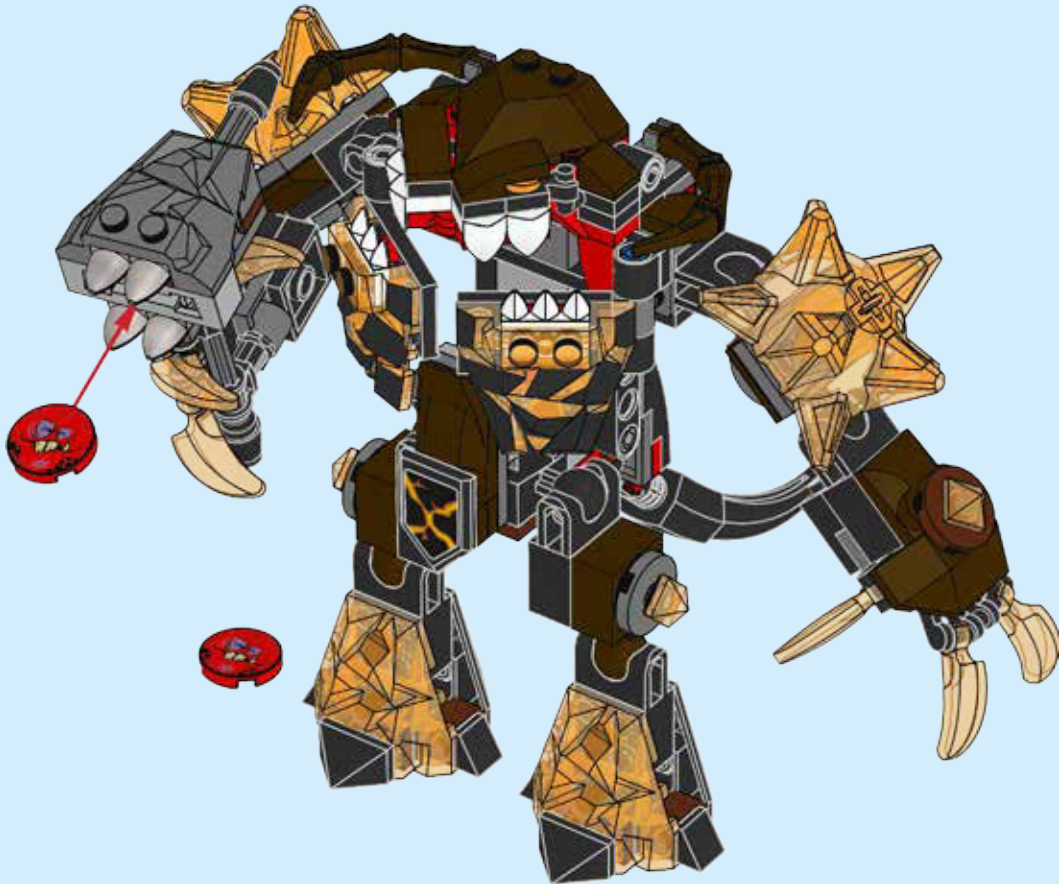

78

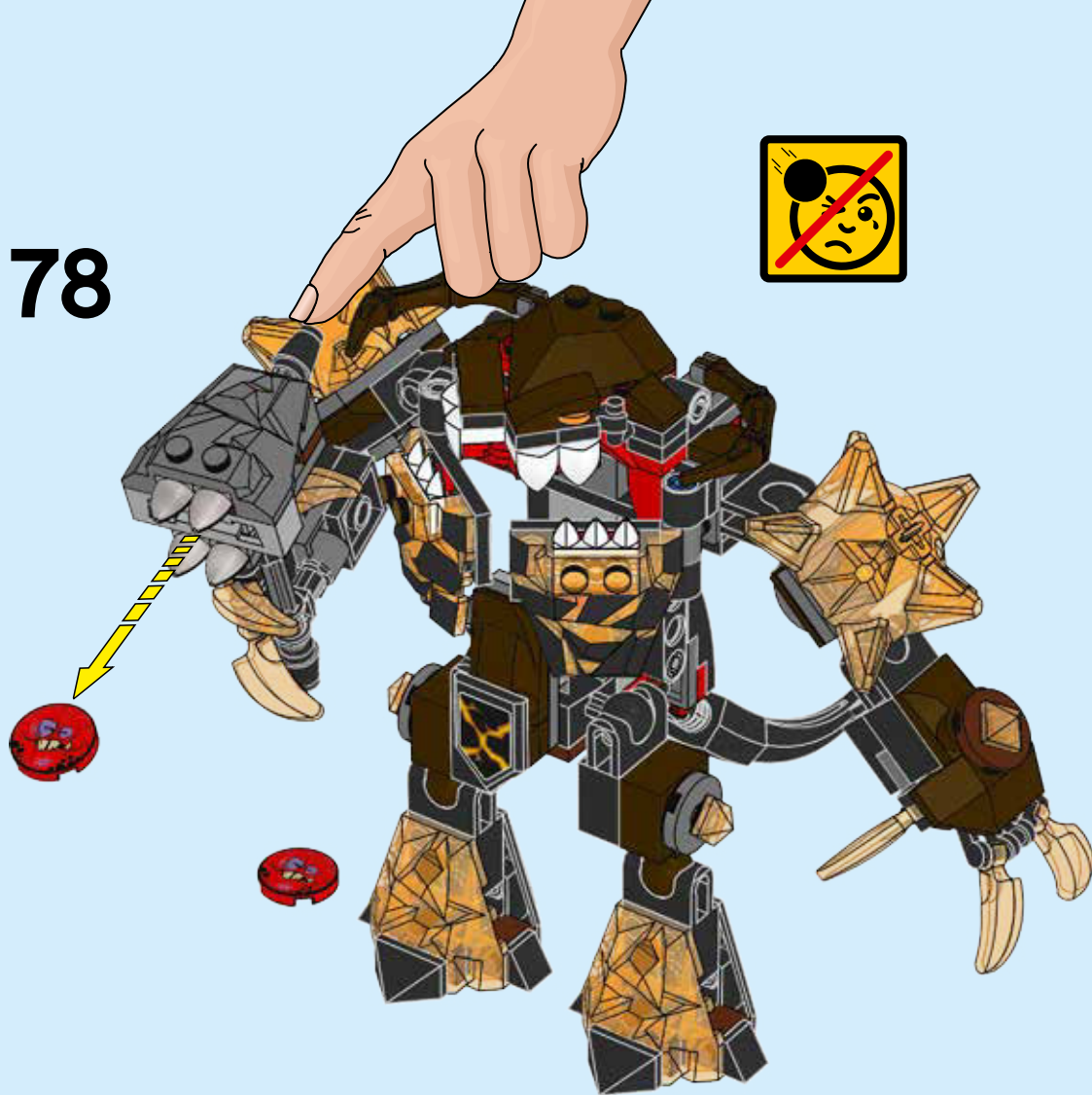





# NEXO KNIGHTS



05813.240070

7500896.554100

70325 + 70317



05813.240070





# NEXO KNIGHTS



DOWNLOAD  
THE FREE APP



LEGO® NEXO KNIGHTS™: MERLOK 2.0



1



2



3

DOWNLOAD THE FREE APP/KOSTENLOSE APP HERUNTERLADEN/TÉLÉCHARGE L'APPLI GRATUITE  
DESCARGA LA APP GRATIS/DESCARREGA A APP GRÁTIS/TÖLTSD LE AZ INGYENES APPOT/下載免費APP  
DEVICE CHECK;/GERÄT PRÜFEN;/VERIFICATION DE COMPATIBILITE :  
COMPRUEBA TU DISPOSITIVO;/VERIFICAÇÃO DO DISPOSITIVO;/ESZKÖZZELLENÖRZÉS;/設備檢查:

[LEGO.com/devicecheck](http://LEGO.com/devicecheck)



# NEXO KNIGHTS

## SCANNING TIPS

Scanning Tips / Tipps zum Scannen / Conseils de scannage /  
Consejos para escanear / Dicas para o scan /  
Beolvási tippek / 扫描秘诀





# NEXO KNIGHTS



LEGO  
LEGOLAND  
DISCOVERY CENTER

# LEGOLAND



DOWNLOAD THE FREE APP; /KOSTENLOSE APP  
HERUNTERLADEN; /TÉLÉCHARGE L'APPLI GRATUITE ;/  
DESCARGA LA APP GRATIS; /DESCARREGA A APP GRATIS;/  
TÖLTSD LE AZ INGYENES APPOT!; /下载免费 APP;  
LEGO® NEXO KNIGHTS™: MERLOK 2.0

**ALL MATERIALS MIGHT NOT BE AVAILABLE IN ALL MARKETS.**

MÖGLICHERWEISE IST NICHT DAS GANZE MATERIAL IN ALLEN MÄRKTEN VERFÜGBAR. /CERTAINS PRODUITS PEUVENT NE PAS ÊTRE DISPONIBLES SUR CERTAINS MARCHÉS. /CIERTOS MATERIALES PODRÍAN NO ESTAR DISPONIBLES EN TODOS LOS MERCADOS. /OS MATERIAIS PODERÃO NÃO ESTAR TODOS DISPONÍVEIS EM TODOS OS MERCADOS. /ELKÉPZELHETŐ, HOGY BIZONYOS KIEGÉSZÍTŐK A TE ORSZÁGODBAN NEM ELÉRHETŐEK. /部分内容可能不适用于某些国家/地区

[LEGO.COM/NEXOKNIGHTS](http://LEGO.COM/NEXOKNIGHTS)



# NEXO KNIGHTS







# NEXO KNIGHTS



**SPARKKS**  
70316



**JESTRO**  
70316



**BOOK OF MONSTERS**  
70316



**MOLTOR**  
70313



**BEAST MASTER**  
70314



**ULTIMATE BEAST MASTER**  
70334



**ULTIMATE LAVARIA**  
70335



**CRUST SMASHER**  
70311



**ASH ATTACKER**  
\* 70310 / 70315 / 70317



**FLAME THROWER**  
70312



**SCURRIER**  
\* 70315 / 70317

\* Weapons and decorations vary by set/Zubehör und Dekoration variieren je nach Set/Les armes et les décorations varient selon les boîtes/



**ULTIMATE CLAY**  
70330

**ULTIMATE MACY**  
70331

**ULTIMATE AARON**  
70332

**ULTIMATE ROBIN**  
70333

NEXT POWER UP



**AARON**  
\* 70313 / 70317



**AXL**  
70317

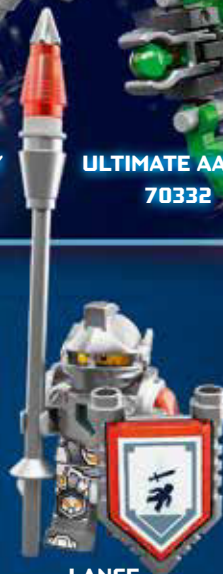

**LANCE**  
\* 70312 / 70316



**CLAY**  
\* 70315 / 70317



**MACY**  
70314



**CHEF ÉCLAIR**  
70317



**LANCE BOT**  
70312



**CLAY BOT**  
70315



**ROYAL SOLDIER**  
\* 70310 / 70311



**MERLOK 2.0**  
70317





# NEXO KNIGHTS







# NEXO KNIGHTS



PER UPLOAD



70317



70316



70315



70314



70313



70312



70311



70310



70330



70331



70332



70333



70334



70335



# NEXO KNIGHTS

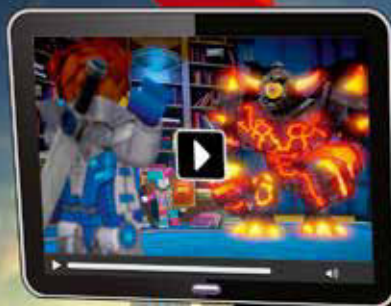

[LEGO.COM/NEXOKNIGHTS](http://LEGO.COM/NEXOKNIGHTS)

